

# Battery Energy Storage Station Based Smoothing Control of Wind Power Generation Fluctuations

<sup>1</sup>Mr. Rahul Charles C M, <sup>2</sup>Ms. DainaShaji, <sup>3</sup>Mr. Sudheesh S, <sup>4</sup>Ms. SerinKurien

PG Scholar, Dept. of EEE, Govt. Engineering College Barton Hill, Trivandrum, Kerala<sup>1</sup>  
M. Tech Graduate in Power Systems, Saintgits College of Engineering, Kottayam, Kerala<sup>2</sup>  
M. Tech Graduate in Power Systems, Saintgits College of Engineering, Kottayam, Kerala<sup>3</sup>  
M. Tech Graduate in Power Systems, Saintgits College of Engineering, Kottayam, Kerala<sup>4</sup>

**Abstract**—Due to population growth and economic development the energy demand is increasing day by day. Fossil fuel sources like oil, coal are costly and causing serious pollution to the environment. Wind energy generation is under renewable energy source it is a feasible solution to energy shortage. The wind speed variations cause's serious power quality problems during integration of wind turbine with the grid. For power control rotor side converter and grid side converter are used. The DFIG is capable of producing power in above and below synchronous speed. The power supplied to the grid through stator and rotor. In this paper, a battery energy storing system (BESS) is introduced in between the inverter and converters section. Since the converters and BESS are introduced in the rotor side their rating can be reduced. The implementation of Fuzzy-PI controller improves transient performance of the system. The system is simulated in MATLAB/SIMULINK and results are presented.

**Keywords**—Doubly fed induction generator (DFIG), Battery energy storing system (BESS), Power electronic converters (PEC), Wind turbine, Rotor Side Converter (RSC), Grid Side Converter (GSC)

## INTRODUCTION

Wind energy generation is under renewable energy source it is a feasible solution to energy shortage. China has the most installed wind energy capacity, followed by the United States, Germany, Spain and India. Wind energy is one of the fastest growing energy production industry at present situation and it will continue to grow worldwide, as many countries have plans for future development. The Indian wind energy sector has an installed capacity of 18.55 GW. However the output power of wind generator is fluctuating due to wind speed variations. This will causes serious problems in the distribution network. Wind turbines can either operate at fixed speed or variable speed. For a fixed speed wind turbine the generator is directly connected to the electrical grid. For a variable speed wind turbine the generator is controlled by power electronic equipment. Because of the advantages of the DFIG over other generators it is being used for most of the

wind power applications. DFIG wind turbines dominate the market due to cost-effective provision of variable-speed operation.

The DFIG has the ability to control electrical torque and reactive power helps to provide better performance considering the system stability. DFIG is basically an induction generator with the multiple winding that is directly connected to the electrical grid and three phase rotor winding which is also connected to the grid via slip rings. A squirrel-cage induction generator, which has its rotor short-circuited, a DFIG has its rotor terminals accessible. In the DFIG concept, the wound-rotor induction generator is grid-connected at the stator terminals, as well as the rotor terminals through a partially rated variable frequency ac/dc/ac converter (VFC), which only needs to handle a fraction (25%-30%) of the total power to achieve full control of the generator. The battery energy storing system is introduced in between the inverter and converter sections.

## II TYPES OF WIND TURBINES

### 1. Fixed speed induction generator

The first kind of turbines uses one or two asynchronous squirrel cage induction generators. The power produced is made constant by varying the slip slightly. They are self-exciting and no need of slip rings and can be grid connected without the need of the power electronic devices. Due to some advantages like simple design, lower cost and easy maintenance they commonly used in power system

### 2. Synchronous generator with full converter

These types of wind turbines uses full scale power electronic equipment's. The generator may be permanent magnet synchronous generator (PMSG) or wound rotor types. Instead of directly connecting the stator they are connected through rated power electronic converters the converter is back to back voltage source converter. The power control can be adjusted by pitch angle control. Due to fully rated power electronic converters they are more costly.

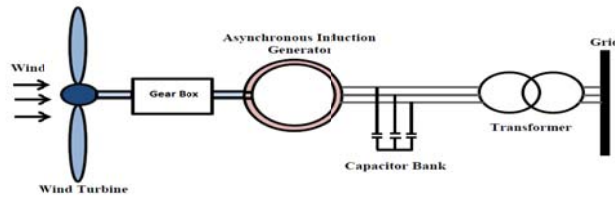

Fig.1. Fixed speed induction generator

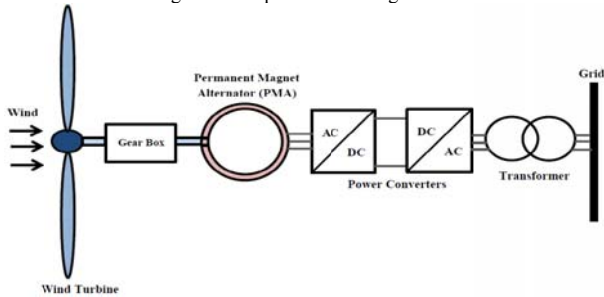

Fig.2. Synchronous generator with full converter

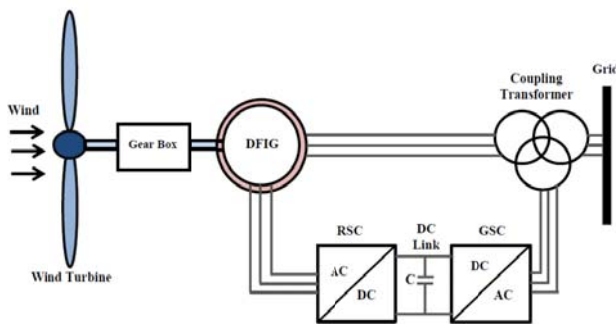

Fig.3. Doubly fed induction generator

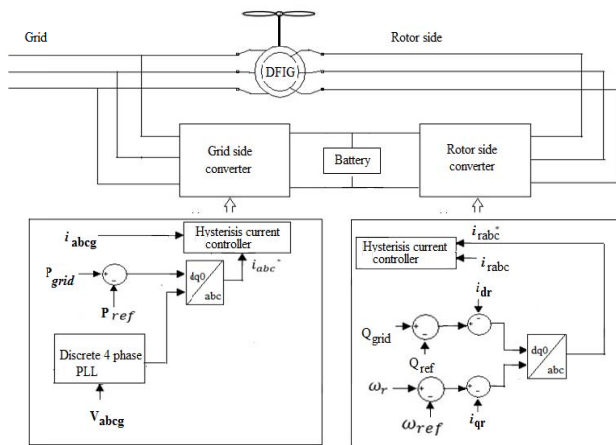

Fig.4. DFIG control scheme

### 3. Doubly fed induction generator (DFIG)

In DFIG the stator winding is directly connected to the grid and the rotor winding is connected to the grid through power electronic converters. The power electronic converter used is a

voltage source converter. The power electronic converters will help to compensate the difference between mechanical and electrical frequencies by providing rotor voltage with the changing frequencies. Thus the variable frequency of operation is possible. The converters used in the DFIG is only a fraction of the rated power of the turbine [1]

### III CONTROL STRATEGY

This section describes how the control scheme is implemented in DFIG. The main advantages decoupled control of active and reactive power is possible. Here two back to back converters are used so we need to control these two converter sides. These two controllers are known as RSC and GSC. Based on the wind speed the power is allowed to flow on both directions in the rotor side.

#### 1. Control of Rotor Side Converter (RSC)

The DFIG is controlled in the stator flux oriented reference frame. In stator flux oriented reference frame the d axis component of current is oriented along the stator flux position. The RSC is mainly used for extracting maximum power from the wind turbines also for maintaining low reactive power in the DFIG[2]. For this the reactive power set point is set to zero [3]. The proportional-integral controller (PI) controller is used for the regulation of reactive power and rotor speed. The reference rotor currents  $i_{rdref}$  and  $i_{rqref}$  are obtained. Then “(1)” and “(2)” reference d-axis and q-axis components are compared with instantaneous values of d-axis and q-axis components of rotor currents

$$i_{dref} = (K_{prsc} + \frac{K_{irec}}{s})(i_{rd} - i_{rdref}) \quad (1)$$

$$i_{qref} = (K_{prsc} + \frac{K_{irec}}{s})(i_{rq} - i_{rqref}) \quad (2)$$

$i_{rd}$  and  $i_{rq}$  are the instantaneous values of d-axis and q-axis components of rotor currents. Then this reference current is compared with the instantaneous values of rotor currents clock pulses are generated [4].

#### 2. Control of Grid Side Converter (GSC)

The power which has to be maintained constant is obtained from the average power based on the wind speed variations calculated earlier. This power is given as reference power to the grid side converter. This reference power is compared with instantaneous value of the grid power. The reference d axis component of the current is obtained as

$$i_{rdref} = (K_{prsc} + \frac{K_{irec}}{s})(Q_{grid} - Q_{ref}) \quad (3)$$

$$i_{rqref} = (K_{prsc} + \frac{K_{irec}}{s})(\omega_{rotor} - \omega_{ref}) \quad (4)$$

d-q-o to a-b-c transformation it is compared with the instantaneous values of grid currents clock pulses are generated.

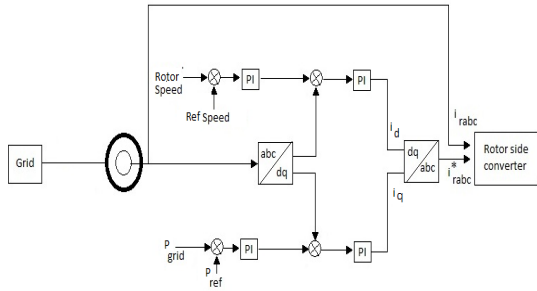

Fig .5.Control of Rotor Side Converter

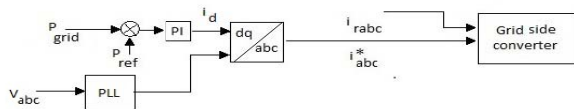

Fig.6 Control of Grid Side Converter

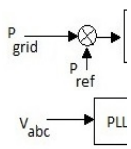

Fig .7.Control Converter controller

e\Δe	E	PE
NP	PB	PM
NM	PM	PM
ZE	ZE	NM
PM	NM	NM
PB	NM	NB

of Grid Side using Fuzzy PI  
Fuzzy rule table

TABLE I:

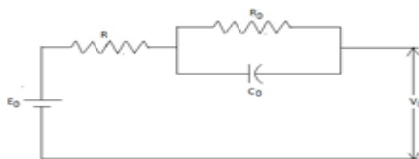

Fig.8.. Battery model

During transient condition that is when there is a large change in wind speed variations the power oscillation is too high here. In order to limit this power oscillation the PI controller in the GSC is replaced by using Fuzzy PI controller. The usage of fuzzy logic controller will reduce the settling time also small amount of overshoot also this variation[5].

### IBattery Modeling

The most commonly used battery model is Thevenin battery model. The equivalent resistance of internal and external series and parallel or series combination of battery is represented by R. This equivalent resistance is usually taken as very small value. The R<sub>0</sub> and C<sub>0</sub> represents the capacitance of the parallel plates and non-linear resistance due to contact resistance. R<sub>0</sub> in parallel with the C<sub>0</sub> represents self-discharging of the battery[6].The value of capacitance C<sub>0</sub> is determined by

$$C_0 = \frac{kWh \times 3600 \times 10^3}{0.5(V_{max}^2 - V_{min}^2)} \quad (5)$$

### IVSimulation results

The wind speed is varied from 10 to 20 m/s.Initially the wind speed is 10 m/s. Then it is varied to 20 m/s at 2.5 sec.then it is varied to 20 m/s at 4sec, then is varied to 13.7

m/sec it is the rated wind speed of the wind turbine. At time t=6 sec the wind speed is reduced to zero. The wind speed variations with respect to the time is shown in the figure 9.

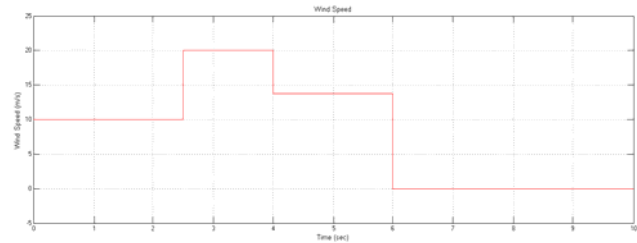

Fig.9. Wind speed variations with respect to time

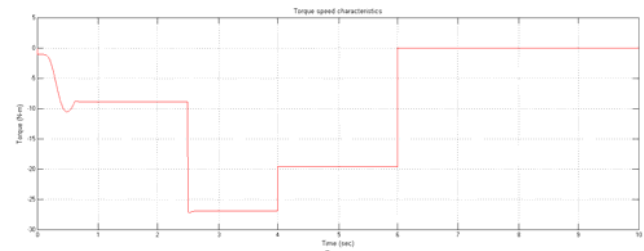

Fig .10. Torque speed characteristics

The corresponding variations in torque is shown in the figure.The negative torque means generation. The corresponding variations in the active power supplied by the stator and BESS of the DFIG is shown in the figure 11 and 12.

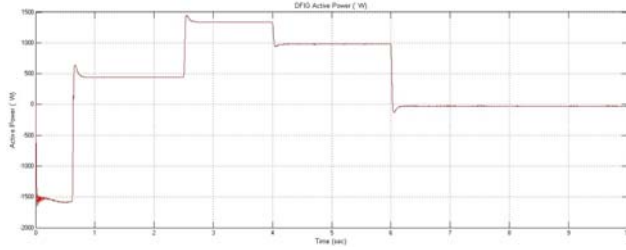

Fig. 11. Active power supplied by the stator of the DFIG

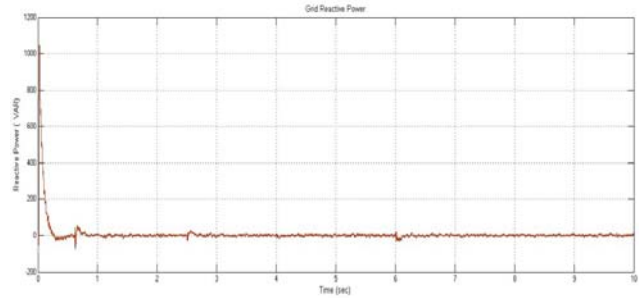

Fig. 14. Grid reactive power

The grid reactive power is maintained to zero it is independent of wind speed variations. This is shown in the figure 14 .

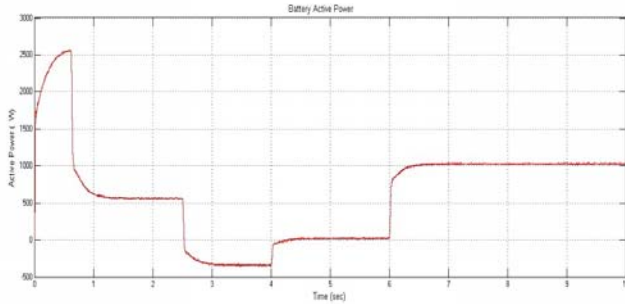

Fig. 12. Active power supplied by the stator of the BESS

The sum of the active power supplied by the stator of the DFIG and BESS gives the total grid power. the battery will store the additional amount of power available in the grid. This power is represented by negative value in the battery power from 2.5 ms to 5 ms. Then it is varied to 13.5 m/s at this time the DFIG is capable of producing 1000 w. Then finally the wind speed is made to 0 m/s. During this period the BESS is completely capable of producing 1000W.

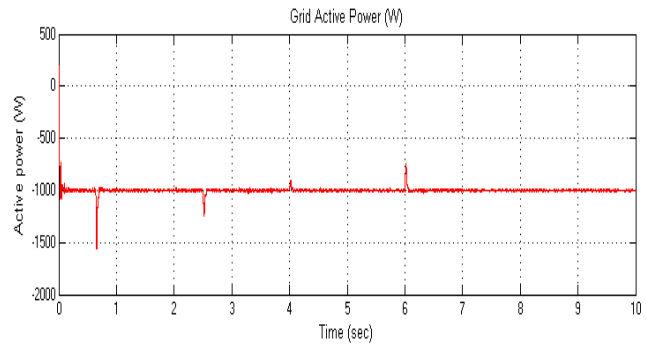

Fig. 15. Grid power using using Fuzzy PI controller

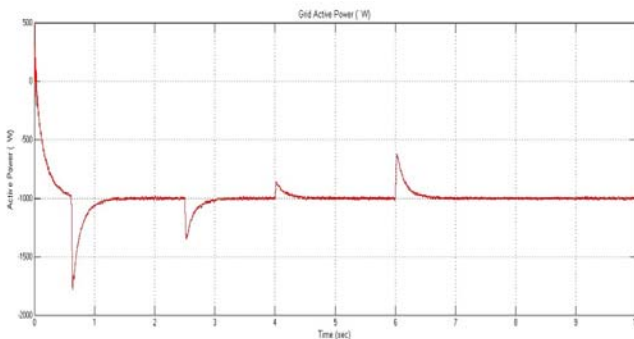

Fig. 13. Grid power variations with respect to time

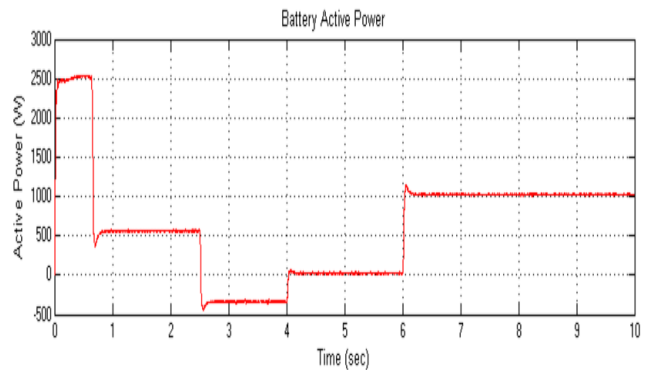

Fig. 16. BESS power using using Fuzzy PI controller

By using Fuzzy PI controller of charging and discharging is improved . The the settling time of BESS and GRID power is tabled in TABLE II. Thus better performance is obtained for Fuzzy PI controller.

TABLE II SETTLING TIME OF BESS AND GRID POWER

Wind speed (m/s)	10	20	13.7	0
------------------	----	----	------	---

BESS Settling time (s)				
PI	1.2	0.5	0.3	0.4
Fuzzy PI	0.8	0.2	0.1	0.1
Grid power Settling time(s)				
PI	1.2	0.5	0.3	0.4
Fuzzy PI	0.6	0.2	0.1	0.1

#### IV CONCLUSION

The work presented in this thesis is committed to control and grid-synchronization of the doubly-fed induction generator. A DFIG d-q steady state model is developed to study the real and reactive power control in stator-voltage and stator-flux oriented frame. The simulation results show that the active power of grid is by using GSC and is independent of varying wind speed. The machine torque is obtained as negative this shows that the DFIG is operating as generator. If the PI controller in the GSC is replaced by Fuzzy PI controller the transient response is improved. The simulation was done in MATLAB/Simulink

#### REFERENCES

- [1] R. Pena, J.C. Clare, G.M. Asher “ Doubly fed induction generator using back-to-back PWM converters and its application to variable speed wind-energy generation,”
- [2] M. Boutoubat , L. Mokrani “Control of a wind energy conversion system equipped by a DFIG for active power generation and power quality improvement,” *Renewable Energy* 50 (2013) 378-386
- [3] J.S. Lather, S.S Dhillon, “Modern control aspects in dfig based power systems :A review,” *IJAREEIE* Vol. 2, Issue 6, June 2011
- [4] Vijay Chand Ganti, Bhim Singh, Fellow, IEEE, Shiv Kumar Aggarwal, and Tara Chandra Kandpal “DFIG-based wind power conversion with grid power leveling for reduced gusts,” *IEEE transactions*, VOL. 3, NO. 1, JANUARY 2012
- [5] Marwan Rosyadi, “ Fuzzy-PI Controller Design for PM Wind Generator to Improve Fault Ride Through of Wind Farm” *IJRER* Vol.3, No.2, 2013
- [6] Bhim Singh, Senior Member, IEEE, and Gaurav Kumar Kasal “Voltage and frequency controller for a three-phase four-wire autonomous wind energy conversion system,” *IEEE transactions*, VOL. 23, NO. 2, JUNE 2008